

BKS 9220 T

Vacuum Cleaner
User Manual

BEKO

Read this manual prior to initial operation of the product!

Dear Customer,

We hope that your product, which has been manufactured in modern facilities and passed through a strict quality control procedure, will give you very good results.

We advise you to read through this manual carefully before using your product and keep it for future reference.

The User Manual will help you use your machine in a fast and safe way.

- Read the User Manual before installing and starting your product.
- In particular, follow the instructions related to safety.
- Keep this User Manual within easy reach for future reference.
- Also read all additional documents supplied with this product.

Remember that this User Manual is also applicable for several other models. Differences between models will be identified in the manual.



This product has been produced in environmentally friendly, modern facilities



CONTENT

1 Safety Warnings	2
2 Technical Specifications of Your Appliance	3
3 Operating Your Appliance	4-6
4 Maintenance and Cleaning	7

1 Safety Warnings

- You may only use your vacuum cleaner if the voltage indicated on the label under your vacuum cleaner complies with the supply voltage. Otherwise, the motor may be damaged.
- Never leave your vacuum cleaner plugged in. Unplug your appliance when not in use or when service is required.
- Do not use your vacuum cleaner on wet floors and outdoors.
- Physically (audio, visual) impaired and mentally handicapped persons and those without proper experience and knowledge as well as children may not use the product without supervision of a person in charge of their safety. Children must be kept under supervision when the product is in use and it must be made sure that children do not tamper with the product.
- If the supply cable or plug is damaged, or if your appliance does not work due to dropping, damage, exposing to outer conditions or wetting, refer to the authorized services.
- Do not pull the appliance from the supply cable. Keep the supply cable away from sharp edges, hot surfaces and pay attention not to pinch it between door frames.
- Do not unplug by pulling the cable. Always hold the plug to take it out from the socket.
- Do not touch the plug or the appliance with wet hands.
- Do not drop anything on to the exposed parts of your vacuum cleaner. Pay attention that the air ducts and openings are always open.
- Keep your hands, hair and clothes away from the running parts of the appliance.
- Do not use your vacuum cleaner to clean combustible substances such as lit cigarettes, matches or hot ash.
- Always turn off all control buttons on your vacuum cleaner prior to unplugging it.
- Do not absorb combustible and explosive liquids with your vacuum cleaner. Do not use your vacuum cleaner at areas where such liquids exist.
- Always unplug the appliance prior to attaching or replacing the supplied accessories.
- Do not operate your vacuum cleaner in a vertical position to the floor.
- Do not use your vacuum cleaner when its filters are not attached and without putting water in it. Things to be done for energy saving
- If your vacuum cleaner is featured with absorption power adjustment, you can have the appliance draw less energy.
- Cleaning your product's filters frequently or replacing the same will both increase your product's performance and also decrease cleaning time which will provide energy saving.

2 Technical Specifications of Your Appliance

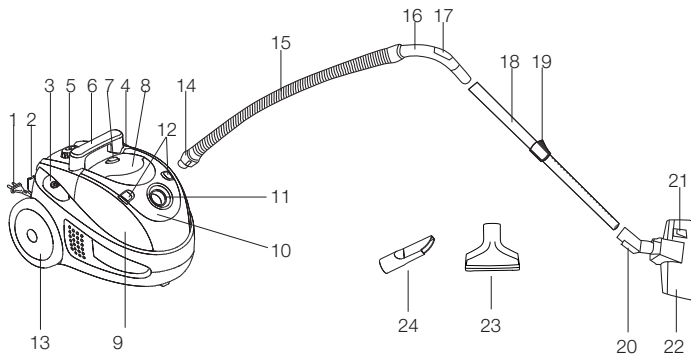

- 1- Plug and supply cable
- 2- Carpet brush holder
- 3- Cable rewind switch
- 4- On/Off button
- 5- Absorption power adjustment button
- 6- Carriage handle
- 7- Water container remove button
- 8- Water container carriage handle
- 9- Water container
- 10- Water container filter assembly
- 11- Appliance suction nozzle
- 12- Filter assembly opening buttons
- 13- Rear Wheel
- 14- Hose cap
- 15- Flexible hose
- 16- Handle
- 17- Mechanical adjustment slide

- 18- Telescopic extension pipe
- 19- Telescopic adjustment latch
- 20- Carpet brush parking hook
- 21- Carpet brush adjustment latch
- 22- Parquet carpet brush
- 23- Wide-mouth lead
- 24- Narrow-mouth lead
- 25- Turbo Brush

Max. power: 2000 W

Net weight: 5.7 kg

Electrical values: 220-240V AC
50 Hz

Dust capacity: 2.1 lt

Usage radius: 8 m

Filter level: 6 steps

All declared values on the product and on the printed leaflets are picked up after laboratory measurements performed according to related standards. These values may differ upon usage and ambient conditions.

3 Operating Your Appliance

Press lock button to pull out the water container (Figure 1) from the appliance by holding from handle.

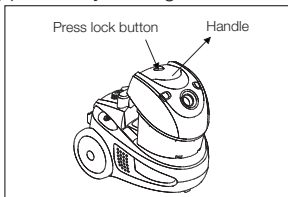

Figure 1

Remove the filter unit being held horizontally by means of two snap-on buttons from the water container (Figure 2)

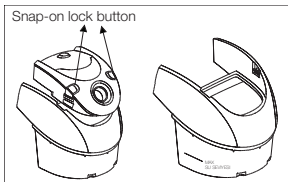

Figure 2

Fill the water container with normal tap water up to the MAX level mark as shown in Figure 2. Required water amount is 600 ml. Install the filter unit back on the water container paying attention to aligning it properly. Install the water container on the appliance again.

Pull out the plug and cable at the back of the product and plug it into the socket. Stop pulling when

the yellow mark on the supply cable comes out, a red mark will come after the yellow mark; never pull further than the red mark. Otherwise, you may damage your product's cable winder.

Attach the hose assembly supplied with your product on to your vacuum cleaner. To start the vacuum cleaner, first press the On/Off button. (Figure 3)

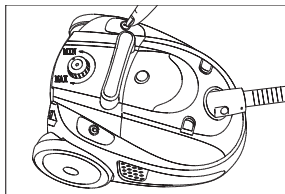

Figure 3

To rewind the cable after vacuum cleaning process is completed press the cable winding button on your appliance. (Figure 4) Do not step on the cable winding button. Mechanism may be damaged if it is pressed forcefully by foot.

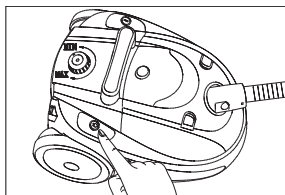

Figure 4

You may adjust the suction power of your product while carrying out vacuum cleaning process by means of the suction adjustment button located on the body. (Figure 5)

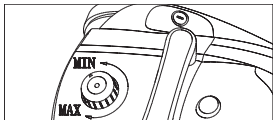

Figure 5

You can attach the hose adaptor to your vacuum cleaner by pushing fast the tabs on the hose adaptor in the direction of the arrow without forcing as shown in Picture 6.

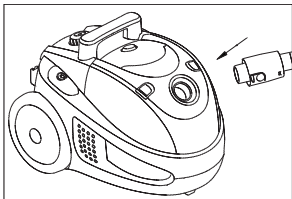

Figure 6

Your product's hose is featured to rotate 360°. Thus, it provides an ergonomic usage during cleaning. (Figure 7)

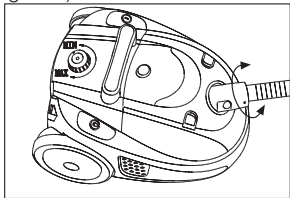

Figure 7

Make sure that the tabs on the hose adaptor in Picture 7 are securely fitted in their places. To remove the hose from the vacuum cleaner, press on the tabs on the hose adaptor and pull it backwards.

You can carry your product by using the carriage handle on top of it. (Figure 8)

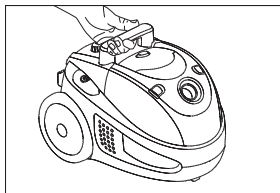

Figure 8

Using the extension pipe

Your product's extension pipe has a telescopic characteristic. To extend the pipe, press the latch shown in the direction of the arrow and pull from the pipe end. You can adjust the length as you wish. (Figure 9)

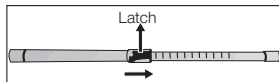

Figure 9

Narrow-mouth lead

It can be used for unreachable narrow openings on arm-chairs and furniture. (Figure 10)

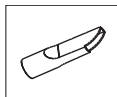

Figure 10

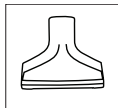

Figure 11

Wide-mouth lead

It is used to clean floors, steps, inside of cars, sofas, arm-chairs, etc.. (Figure 11)

Using the parquet and carpet brush

There is an adjustment mechanism at the side of the parquet and carpet brush. The brush is aligned to the surface to be cleaned by means of the adjustment mechanism. (Figure 13)

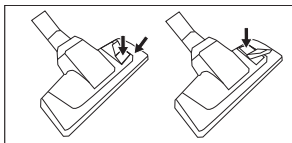
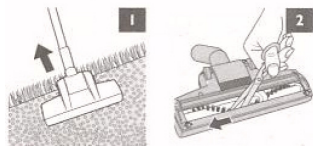

Figure 13

- a) Use your brush in normal position (brush hair in hidden position) for carpets and rugs
- b) While cleaning hard floors such as parquets, marley floors, linoleum and flat surfaces such as walls without scratching them, change the position of the adjustment mechanism to clean them with bristle brushes.

Using the Turbo Brush



It is particularly efficient in collecting the pet hairs. It cleans the carpets in depth. When vacuum cleaning the fringes of the carpet, use the brush by pulling it backwards in the direction of the arrow. Clean threads and hair entangled on the brush by cutting them with a pair of scissors.

Turning off and storing the vacuum cleaner

Press the On/Off button on the body to stop operation of the vacuum cleaner. Do not unplug the appliance at once to stop the product operation; first press the On/Off button and stop the operation of the appliance. (Figure 3) Moreover, you can store your appliance horizontally by attaching the parking part on the back of your product's brush to the parking slot at the back of the product. (Figure 14)

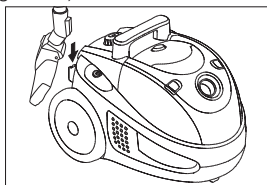
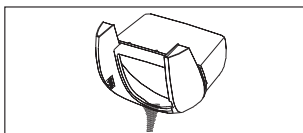

Figure 14

4 Maintenance and Cleaning

EMPTYING AND CLEANING THE WATER CONTAINER

Turn off your appliance by the on/off button and unplug it. Remove the water container by holding from the handle (Figure 2). Remove the filter unit and turn it upside down so that the opened part points downwards, and empty it (Figure 15).



(Figure 15)

Filter unit may be detached from the container (Figure 16) and washed in the water.

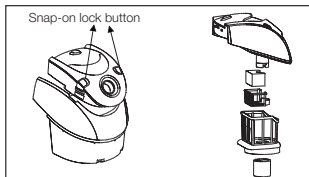

(Figure 16)

HEPA filter and sponge filters may be removed from the appliance and washed (Figure 17 and Figure 18).

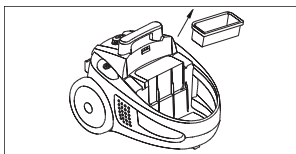

(Figure 17)

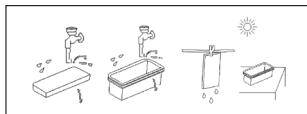

(Figure 18)

Furthermore, the exhaust sponge must be washed clean every 6 months by opening the exhaust filter cover at the rear side of the appliance.

If you wish to carry on vacuum cleaning, fill with water up to the relevant level and wait until the filter unit and the HEPA filter get dry before replacing them back on the appliance. Place the related parts into the filter cage and re-attach the filter unit in the appliance. Now, the appliance is ready to be stored.

Note: Water in the container does not damage the appliance; however, it is recommended that you empty the appliance before storing it. One of the greatest advantages of this appliance is that, contrary to the vacuum cleaners that have to be stored with the dust in their bags, it can be stored as cleaned.

