

# Washing Machine

## User Manual

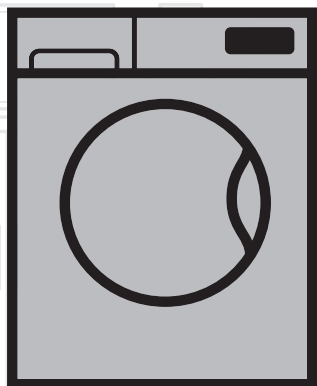

EV 7102

EN

Document Number= 2820524450/14-10-15.(16:19)

**beko**

# **1 Important instructions for safety and environment**

---

This section contains safety instructions that will help protect from risk of personal injury or property damage. Failure to follow these instructions shall void any warranty.

## **1.1 General safety**

- This product can be used by children at and above 8 years old and by persons whose physical, sensory or mental capabilities were not fully developed or who lack experience and knowledge provided that they are supervised or trained on the safe usage of the product and the risks it brings out. Children must not play with the product. Cleaning and maintenance works should not be performed by children unless they are supervised by someone. Children of less than 3 years should be kept away unless continuously supervised.
- Never place the product on a carpet-covered floor. Otherwise, lack of airflow beneath the machine will cause electrical parts to overheat. This will cause problems with your product.
- If the product has a failure, it should not be operated unless it is repaired by the Authorized Service Agent. There is the risk of electric shock!
- This product is designed to resume operating in the event of powering on after a power interruption. If you wish to cancel the programme, see "Cancelling the programme" section.
- Connect the product to a grounded outlet protected by a 16 A fuse. Do not neglect to have the grounding installation made by a qualified electrician. Our company shall not be liable for any damages that will arise when the product is used without grounding in accordance with the local regulations.
- The water supply and draining hoses must be securely fastened and remain undamaged. Otherwise, there is the risk of water leakage.
- Never open the loading door or remove the filter while there is still water in the drum. Otherwise, risk of flooding and injury from hot water will occur.
- Do not force open the locked loading door. The loading door will be ready to open just a few minutes after the washing cycle comes to an end. In case of forcing the loading door to open, the door and the lock mechanism may get damaged.
- Unplug the product when not in use.
- Never wash the product by spreading or pouring water onto it! There is the risk of electric shock!
- Never touch the plug with wet hands! Never unplug by pulling on the cable, always pull out by grabbing the plug.



---

This product was manufactured using the latest technology in environmentally friendly conditions.

- Use detergents, softeners and supplements suitable for automatic washing machines only.
- Follow the instructions on the textile tags and on the detergent package.
- The product must be unplugged during installation, maintenance, cleaning and repairing procedures.
- Always have the installation and repairing procedures carried out by the Authorized Service Agent. Manufacturer shall not be held liable for damages that may arise from procedures carried out by unauthorized persons.
- If the power cable is damaged, it must be replaced by the manufacturer, after sales service or a similarly qualified person (preferably an electrician) or someone designated by the importer in order to avoid possible risks.
- Place the product on a rigid, flat and level surface.
- Do not place it on a long-pile rug or similar surfaces.
- Do not place the product on a high platform or near the edge on a cascaded surface.
- Do not place the product on the power cable.
- Never use sponge or scrub materials. These will damage the painted, chrome plated and plastic surfaces.

## 1.2 Intended use

- This product has been designed for domestic use. It is not suitable for commercial use and it must not be used out of its intended use.
- The product must only be used for washing and rinsing of laundry that are marked accordingly.
- The manufacturer waives any responsibility arisen from incorrect usage or transportation.

## 1.3 Children's safety

- Packaging materials are dangerous to children. Keep packaging materials in a safe place away from reach of the children.
- Electrical products are dangerous for the children. Keep children away from the product when it is in use. Do not let them to tamper with the product. Use child lock to prevent children from intervening with the product.
- Do not forget to close the loading door when leaving the room where the product is located.
- Store all detergents and additives in a safe place away from the reach of the children by closing the cover of the detergent container or sealing the detergent package.



While washing the laundry at high temperatures, the loading door glass becomes hot. Therefore, keep especially the children away from the loading door of the machine while the washing operation is in progress.

## 1.4 Package information

- Packaging materials of the product are manufactured from recyclable materials in accordance with our National Environment Regulations. Do not dispose of the packaging materials together with the domestic or other wastes. Take them to the packaging material collection points designated by the local authorities.

## 1.5 Disposing of the waste product

- This product has been manufactured with high quality parts and materials which can be reused and are suitable for recycling. Therefore, do not dispose the product with normal domestic waste at the end of its service life. Take it to a collection point for the recycling of electrical and electronic equipment. Please consult your local authorities to learn the nearest collection point. Help protect the environment and natural resources by recycling used products. For children's safety, cut the power cable and break the locking mechanism of the loading door so that it will be non-functional before disposing of the product.

## 1.6 Compliance with WEEE Directive



This product complies with EU WEEE Directive (2012/19/EU). This product bears a classification symbol for waste electrical and electronic equipment (WEEE).

This product has been manufactured with high quality parts and materials which can be reused and are suitable for recycling. Do not dispose of the waste product with normal domestic and other wastes at the end of its service life. Take it to the collection center for the recycling of electrical and electronic equipment. Please consult your local authorities to learn about these collection centers.

### Compliance with RoHS Directive:

The product you have purchased complies with EU RoHS Directive (2011/65/EU). It does not contain harmful and prohibited materials specified in the Directive.

## 2 Installation

Refer to the nearest Authorized Service Agent for installation of the product. To make the product ready for use, review the information in the user manual and make sure that the electricity, tap water supply and water drainage systems are appropriate before calling the Authorized Service Agent. If they are not, call a qualified technician and plumber to have any necessary arrangements carried out.



### INFORMATIONS

Preparation of the location and electrical, tap water and waste water installations at the place of installation is under customer's responsibility.

Make sure that the water inlet and discharge hoses as well as the power cable are not folded, pinched or crushed while pushing the product into its place after installation or cleaning procedures.



### WARNING

Installation and electrical connections of the product must be carried out by the Authorized Service Agent. Manufacturer shall not be held liable for damages that may arise from procedures carried out by unauthorized persons.



### WARNING

Prior to installation, visually check if the product has any defects on it. If so, do not have it installed. Damaged products cause risks for your safety.

### 2.1 Appropriate installation location

- Place the machine on a rigid floor. Do not place it on a long pile rug or similar surfaces.
- Total weight of the washing machine and the dryer -with full load- when they are placed on top of each other reaches to approx. 180 kilograms. Place the

product on a solid and flat floor that has sufficient load carrying capacity!

- Do not place the product on the power cable.
- Do not install the product at places where temperature may fall below 0°C.
- Place the product at least 1 cm away from the edges of other furniture.

### 2.2 Removing packaging reinforcement

Tilt the machine backwards to remove the packaging reinforcement. Remove the packaging reinforcement by pulling the ribbon.



## 2.3 Removing the transportation locks



### WARNING

Do not remove the transportation locks before taking out the packaging reinforcement.

Remove the transportation safety bolts before operating the washing machine! Otherwise, the product will be damaged.

Loosen all the bolts with a suitable spanner until they rotate freely (C). Remove transportation safety bolts by turning them gently. Attach the plastic covers supplied in the User Manual bag into the holes on the rear panel. (P)

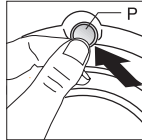
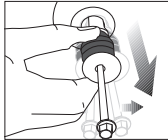
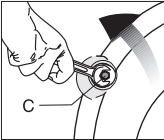

### INFORMATIONS

Keep the transportation safety bolts in a safe place to reuse when the washing machine needs to be moved again in the future.

Never move the product without the transportation safety bolts properly fixed in place!

## 2.4 Connecting water supply



### INFORMATIONS

The water supply pressure required to run the product is between 1 to 10 bars (0.1 - 1 MPa). It is necessary to have 10 - 80 liters of water flowing from the fully open tap in one minute to have your machine run smoothly. Attach a pressure reducing valve if water pressure is higher.

If you are going to use the double water-inlet product as a single (cold) water-inlet unit, you must install the supplied stopper to the hot water valve before operating the product. (Applies for the products supplied with a blind stopper group.)

If you want to use both water inlets of the product, connect the hot water hose after removing the stopper and gasket group from the hot water valve. (Applies for the products supplied with a blind stopper group.)



### WARNING

Models with a single water inlet should not be connected to the hot water tap. In such a case the laundry will get damaged or the product will switch to protection mode and will not operate.

Do not use old or used water inlet hoses on the new product. It may cause stains on your laundry.

Connect the special hoses supplied with the product to the water inlets on the product. Red hose (left) (max. 90 °C) is for hot water inlet, blue hose (right) (max. 25 °C) is for cold water inlet.



### WARNING

Ensure that the cold and hot water connections are made correctly when installing the product. Otherwise, your laundry will come out hot at the end of the washing process and wear out.

Tighten all hose nuts by hand. Never use a wrench when tightening the nuts. Open the taps completely after making the hose

connection to check for water leaks at the connection points. If any leaks occur, turn off the tap and remove the nut. Retighten the nut carefully after checking the seal. To prevent water leakages and damages caused by them, keep the taps closed when the machine is not in use.

## 2.5 Connecting to the drain

- The end of the drain hose must be directly connected to the wastewater drain or to the washbasin.



### WARNING

Do not remove the transportation locks before taking out the packaging reinforcement.

- The hose should be attached to a height of at least 40 cm, and 100 cm at most.
- In case the hose is elevated after laying it on the floor level or close to the ground (less than 40 cm above the ground), water discharge becomes more difficult and the laundry may come out excessively wet. Therefore, follow the heights described in the figure.

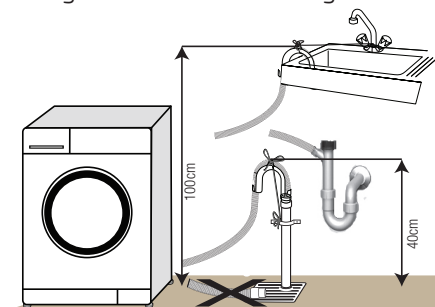

- To prevent flowing of dirty water back into the machine and to allow for easy discharge, do not immerse the hose end into the dirty water or do not drive it in the drain more than 15 cm. If it is too long, cut it short.

- The end of the hose should not be bent, it should not be stepped on and the hose must not be pinched between the drain and the machine.
- If the length of the hose is too short, use it by adding an original extension hose. Length of the hose may not be longer than 3.2 m. To avoid water leak failures, the connection between the extension hose and the drain hose of the product must be fitted well with an appropriate clamp as not to come off and leak.

## 2.6 Adjusting the feet



### WARNING

In order to ensure that the product operates more silently and vibration-free, it must stand level and balanced on its feet. Balance the machine by adjusting the feet. Otherwise, the product may move from its place and cause crushing and vibration problems.

Loosen the lock nuts on the feet by hand. Adjust the feet until the product stands level and balanced. Tighten all lock nuts again by hand.

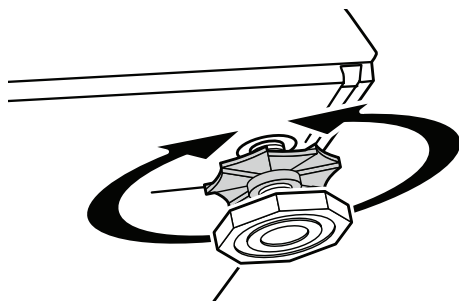

### WARNING

Do not use any tools to loosen the lock nuts. Otherwise, they will get damaged.

## 2.7 Electrical connection

Connect the product to a grounded outlet protected by a fuse complying with the values in the "Technical specifications" table. Our company shall not be liable for any damages that will arise when the product is used without grounding in accordance with the local regulations.

- Connection must comply with national regulations.
- Power cable plug must be within easy reach after installation.
- The voltage and allowed fuse or breaker protection are specified in the "Technical specifications" section. If the current value of the fuse or breaker in the house is less than 16 Amps, have a qualified electrician install a 16 Amp fuse.
- The specified voltage must be equal to your mains voltage.
- Do not make connections via extension cables or multi-plugs.



### WARNING

Damaged power cables must be replaced by the Authorized Service Agents.

## 2.8 First use

Before starting to use the product, make sure that all preparations are made in accordance with the instructions in sections "Important safety instructions" and "Installation".

To prepare the product for washing laundry, perform first operation in Cotton-90 programme. Before starting the programme, put max. 100 g of powder anti-limescale into the main wash detergent compartment (compartment nr. II). If the anti-limescale is in tablet form, put only one tablet into compartment nr. II. Dry the inside of the bellow with a clean piece of cloth after the programme has come to an end.



### INFORMATIONS

Use an anti-limescale suitable for the washing machines.

Some water might have remained in the product due to the quality control processes in the production. It is not harmful for the product.

## 2.9 Disposing of packaging material

Packaging materials are dangerous to children. Keep packaging materials in a safe place away from reach of the children.

Packaging materials of the product are manufactured from recyclable materials. Dispose of them properly and sort in accordance with recycled waste instructions. Do not dispose of them with normal domestic waste.

## 2.10 Transportation of the product

Unplug the product before transporting it. Remove water drain and water supply connections. Drain the remaining water in the product completely; see, "Draining remaining water and cleaning the pump filter". Install transportation safety bolts in the reverse order of removal procedure; see, "Removing the transportation locks".



### INFORMATIONS

Never move the product without the transportation safety bolts properly fixed in place!

## 2.11 Disposing of the old product

Dispose of the old product in an environmentally friendly manner. Refer to your local dealer or solid waste collection centre in your area to learn how to dispose of your product.

For children's safety, cut the power cable and break the locking mechanism of the loading door so that it will be nonfunctional before disposing of the product.



## 3 Preparation

---

### 3.1 Things to be done for energy saving

Following information will help you use the product in an ecological and energy-efficient manner.

- Operate the product in the highest capacity allowed by the programme you have selected, but do not overload; see, "Programme and consumption table".
- Always follow the instructions on the detergent packaging.
- Wash slightly soiled laundry at low temperatures.
- Use faster programmes for small quantities of lightly soiled laundry.
- Do not use high temperatures for laundry that is not heavily soiled or stained.
- Do not use detergent in excess of the amount recommended on the detergent package.

### 3.2 Sorting the laundry

- Sort laundry according to type of fabric, colour, and degree of soiling and allowable water temperature.
- Always obey the instructions given on the garment tags.

### 3.3 Preparing laundry for washing

- Laundry items with metal attachments such as, underwired bras, belt buckles or metal buttons will damage the machine. Remove the metal pieces or wash the clothes by putting them in a laundry bag or pillow case.
- Take out all substances in the pockets such as coins, pens and paper clips, and turn pockets inside out and brush. Such objects may damage the product or cause noise problem.

- Put small size clothes such as infant's socks and nylon stockings in a laundry bag or pillow case.
- Place curtains in without compressing them. Remove curtain attachment items.
- Fasten zippers, sew loose buttons and mend rips and tears.
- Wash "machine washable" or "hand washable" labeled products only with an appropriate programme.
- Do not wash colours and whites together. New, dark coloured cottons release a lot of dye. Wash them separately.
- Tough stains must be treated properly before washing. If unsure, check with a dry cleaner.
- Use only dyes/colour changers and limescale removers suitable for machine wash. Always follow the instructions on the package.
- Wash trousers and delicate laundry turned inside out.
- Keep laundry items made of Angora wool in the freezer for a few hours before washing. This will reduce pilling.
- Laundry that are subjected to materials such as flour, lime dust, milk powder, etc. intensely must be shaken off before placing into the machine. Such dusts and powders on the laundry may build up on the inner parts of the machine in time and can cause damage.

### 3.4 Correct load capacity

The maximum load capacity depends on the type of laundry, the degree of soiling and the washing programme desired.

The machine automatically adjusts the amount of water according to the weight of the loaded laundry.



#### WARNING

Follow the information in the "Programme and consumption table". When overloaded, machine's washing performance will drop. Moreover, noise and vibration problems may occur.

Laundry types and their average weights in the following table are given as examples.

Laundry type	Weight (g)
Bathrobe	1200
Duvet cover	700
Bed Sheet	500
Pillowcase	200
Tablecloth	250
Towel	200
Men's shirt	200

### 3.5 Loading the laundry

Open the loading door. Place laundry items loosely into the machine. Push the loading door to close until you hear a locking sound. Ensure that no items are caught in the door.



#### INFORMATIONS

The loading door is locked while a programme is running. The door can only be opened a while after the programme comes to an end.



#### WARNING

In case of misplacing the laundry, noise and vibration problems may occur in the machine.

### 3.6 Using detergent and softener Detergent Drawer

The detergent drawer is composed of three compartments:

- (1) for prewash
- (2) for main wash
- (3) for softener
- (\*) in addition, there is siphon piece in the softener compartment.

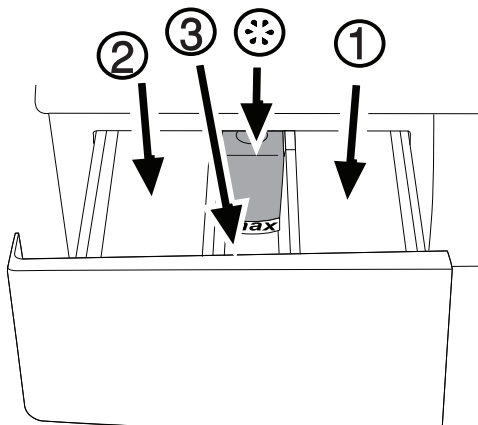

#### Detergent, softener and other cleaning agents

- Add detergent and softener before starting the washing programme.
- Never open the detergent drawer while the washing programme is running!
- When using a programme without prewash, do not put any detergent into the prewash compartment (compartment nr. 1).
- In a programme with prewash, do not put liquid detergent into the prewash compartment (compartment nr. 1).
- Do not select a programme with prewash if you are using a detergent bag or dispensing ball. Place the detergent bag or the dispensing ball directly among the laundry in the machine.

- If you are using liquid detergent, do not forget to place the liquid detergent cup into the main wash compartment (compartment nr. 2).

### 3.7 Choosing the detergent type

The type of detergent to be used depends on the type and colour of the fabric.

- Use different detergents for coloured and white laundry.
- Wash your delicate clothes only with special detergents (liquid detergent, wool shampoo, etc.) used solely for delicate clothes.
- When washing dark coloured clothes and quilts, it is recommended to use liquid detergent.
- Wash woolens with special detergent made specifically for woolens.

 <b>WARNING</b>
Use only detergents manufactured specifically for automatic washing machines.
Do not use soap powder.

### 3.8 Adjusting detergent amount

The amount of washing detergent to be used depends on the amount of laundry, the degree of soiling and water hardness. Read the manufacturer's instructions on the detergent package carefully and follow the dosage values.

- Do not use amounts exceeding the dosage quantities recommended on the detergent package to avoid problems of excessive foam, poor rinsing, financial savings and finally, environmental protection.
- Use lesser detergent for small amounts or lightly soiled clothes.
- Use concentrated detergents in the recommended dosage.

### 3.9 Using softeners

Pour the softener into the softener compartment of the detergent drawer.

- Use the dosages recommended on the package.
- Do not exceed the (>max<) level marking in the softener compartment.
- If the softener has lost its fluidity, dilute it with water before putting it in the detergent drawer.

#### Using bleaches

- Select a programme with prewash and add the bleaching agent at the beginning of the prewash. Do not put detergent in the prewash compartment.
- Do not use bleaching agent and detergent by mixing them.
- Use just a little amount (approx. 50 ml) of bleaching agent and rinse the clothes very well as it causes skin irritation. Do not pour the bleaching agent onto the clothes and do not use it for coloured clothes.
- When using oxygen based bleaches, follow the instructions on the package and select a programme that washes at a lower temperature.
- Oxygen based bleaches can be used together with detergents; however, if its thickness is not the same with the detergent, put the detergent first into the compartment nr. "III" in the detergent drawer and wait until the detergent flows while the machine is taking in water. Add the bleaching agent from the same compartment while the machine is still taking in water.

#### Using limescale remover

- When required, use limescale removers manufactured specifically for washing machines only.
- Always follow instructions on the package.

### 3.10 Tips for efficient washing

		Clothes			
		Light colours and whites	Colours	Dark colours	Delicates/Woolens/Silks
		(Recommended temperature range based on soiling level: 40-90°C)	(Recommended temperature range based on soiling level: cold-40°C)	(Recommended temperature range based on soiling level: cold-40°C)	(Recommended temperature range based on soiling level: cold-30°C)
<b>Soiling Level</b>	<b>Heavily Soiled</b> (difficult stains such as grass, coffee, fruits and blood.)	It may be necessary to pre-treat the stains or perform prewash. Powder and liquid detergents recommended for whites can be used at dosages recommended for heavily soiled clothes. It is recommended to use powder detergents to clean clay and soil stains and the stains that are sensitive to bleaches.	Powder and liquid detergents recommended for colours can be used at dosages recommended for heavily soiled clothes. It is recommended to use powder detergents to clean clay and soil stains and the stains that are sensitive to bleaches. Use detergents without bleach.	Liquid detergents suitable for colours and dark colours can be used at dosages recommended for heavily soiled clothes.	Prefer liquid detergents produced for delicate clothes. Woolen and silk clothes must be washed with special woolen detergents.
	<b>Normally Soiled</b> (For example, stains caused by body on collars and cuffs)	Powder and liquid detergents recommended for whites can be used at dosages recommended for normally soiled clothes.	Powder and liquid detergents recommended for colours can be used at dosages recommended for normally soiled clothes. Use detergents without bleach.	Liquid detergents suitable for colours and dark colours can be used at dosages recommended for normally soiled clothes.	Prefer liquid detergents produced for delicate clothes. Woolen and silk clothes must be washed with special woolen detergents.
	<b>Lightly Soiled</b> (No visible stains exist.)	Powder and liquid detergents recommended for whites can be used at dosages recommended for lightly soiled clothes.	Powder and liquid detergents recommended for colours can be used at dosages recommended for lightly soiled clothes. Use detergents without bleach.	Liquid detergents suitable for colours and dark colours can be used at dosages recommended for lightly soiled clothes.	Prefer liquid detergents produced for delicate clothes. Woolen and silk clothes must be washed with special woolen detergents.

## 4 Operating the product

---

### 4.1 Control panel

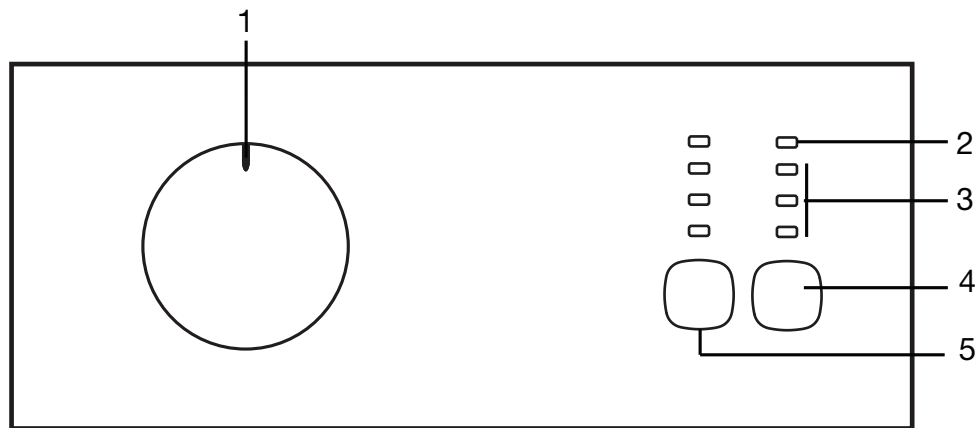

- 1 - Programme Selection knob (Uppermost position On / Off)
- 2 - Door open indicator
- 3 - Programme Follow-up indicator
- 4 - Start / Pause button
- 5 - Spin Speed Adjustment button

## 4.2 Preparing the machine

Make sure that the hoses are connected tightly. Plug in your machine. Turn the tap on completely. Place the laundry in the machine. Add detergent and fabric softener.

### Programme selection

Select the programme suitable for the type, quantity and soiling degree of the laundry in accordance with the "Programme and consumption table" and the temperature table below. Select the desired programme with the Programme Selection button.

90°C	Heavily soiled white cottons and linens. (coffee table covers, tableclothes, towels, bed sheets, etc.)
60°C	Normally soiled, coloured, fade proof linens, cottons or synthetic clothes (shirt, nightgown, pajamas, etc.) and lightly soiled white linens (underwear, etc.)
40°C- 30°C- Cold	Blended laundry including delicate textile (veil curtains, etc.), synthetics and woolens.



#### INFORMATIONS

Use an anti-limesc. Programmes are limited with the highest spin speed appropriate for that particular type of fabric. ale suitable for the washing machines.

When selecting a programme, always consider the type of fabric, colour, degree of soiling and permissible water temperature.

For further programme details, see "Programme and consumption table".

## 4.3 Main programmes

Depending on the type of fabric, use the following main programmes.

### • Cottons

Use this programme for your cotton laundry (such as bed sheets, duvet and pillowcase sets, towels, bathrobes, underwear, etc.). Your laundry will be washed with vigorous washing action for a longer washing cycle.

### • Synthetics

Use this programme to wash your synthetic clothes (shirts, blouses, synthetic/cotton blends, etc.). It washes with a gentle action and has a shorter washing cycle compared to the Cotton programme.

For curtains and tulle, use the Synthetic 40°C programme. As their meshed texture causes excessive foaming, wash the veils/tulle by putting little amount of detergent into the main wash compartment. Do not put detergent in the prewash compartment.

### • Woollens 40°

Use this programme to wash your woolen clothes. Select the appropriate temperature complying with the tags of your clothes. Use appropriate detergents for woolens.

## 4.4 Additional programmes

For special cases, additional programmes are available in the machine.



#### INFORMATIONS

Additional programmes may differ according to the model of the machine.

### • Cottons Eco

Use this programme to wash your laundry washable in cottons programme for a longer time, still with a very good performance for saving purposes.



#### INFORMATIONS

Cottons Eco programme consumes less energy compared to other cottons programmes.

#### • Delicates 30°

Use this programme to wash your delicate clothes. It washes with a gentle action without any interim spin compared to the Synthetics programme.

#### • Hand Wash 20°

Use this programme to wash your woolen/delicate clothes that bear "not machine-washable" tags and for which hand wash is recommended. It washes laundry with a very gentle washing action to not to damage clothes.

#### • Mini 30

Use this programme to wash your lightly soiled cotton clothes in a short time.

#### • Cottons 60° with Prewash

Prefer this programme only for heavily soiled cotton clothes.

### 4.5 Special programmes

For specific applications, select any of the following programmes.

#### • Rinse

Use this programme when you want to rinse or starch separately.

#### • Spin+Drain

Use this programme to apply an additional spin cycle for your laundry or to drain the water in the machine.



#### INFORMATIONS

If you wish to drain the water only without spinning your laundry, select the Spin+Pump programme and press "Start / Pause" button. Machine will switch to spin step once it completes the program step. Press "Start / Pause" button to stop the machine as soon as you see the drum rotating. And cancel this programme by turning Programme Selection knob to any other position.

### 4.6 Spin speed selection

Whenever a new programme is selected, the recommended spin speed of the selected program is displayed on the spin speed indicator.

To decrease the spin speed, press the spin speed adjustment button. Spin speed decreases gradually.

Then, depending on the model of the product, "Rinse Hold" and "No Spin" options appear on the spin speed led indicator.

### 4.7 Rinse Hold

If you are not going to unload your clothes immediately after the programme completes, you may use rinse hold function to keep your laundry in the final rinsing water in order to prevent them from getting wrinkled when there is no water in the machine.

In rinse hold step, the machine will be in pause mode and "start/pause" led will be blinking.

In rinse hold step, if you want to drain the water without spinning your laundry, press the "start/pause" button. Programme will resume and complete after draining the water.

If you want to spin the laundry held in water, select the spin speed and press "start/pause" button. The programme resumes, water is drained, laundry is spun and the programme is completed.

## 4.8 Programme and consumption table

EN						
Programme		Max. Load (kg)	Programme Duration (~ min)	Water Consumption (l)	Energy Consumption (kWh)	Max. Speed***
Cottons 60° with Prewash	60	7	121	66	1.65	1400
Cottons	90	7	133	55	2.10	1400
	40	7	80	55	0.66	1400
	Cold	7	80	55	0.15	1400
Cottons Eco	60**	7	132	52	1.14	1400
	40	3.5	120	46	0.72	1400
Synthetics	60	2.5	113	65	1.10	800
	40	2.5	105	65	0.58	800
	Cold	2.5	66	65	0.11	800
Delicates 30°	30	2	65	48	0.32	800
Woolens 40°	40	1.5	54	52	0.40	800
Hand Wash 20°	20	1	41	35	0.20	800
Mini 30	30	2.5	29	72	0.21	1400

•: Selectable

\*\* : Energy Label programme (EN 60456)

\*\*\*: If maximum spin speed of the machine is lower then this value, you can only select up to the maximum spin speed.



### INFORMATIONS

Water and power consumption may vary subject to the changes in water pressure, water hardness and temperature, ambient temperature, type and amount of laundry, selection of auxiliary functions and spin speed, and changes in electric voltage.



### INFORMATIONS

Cottons Eco 60C is recommended programme for normally soiled clothes.



## 4.9 Starting the programme

Press Start / Pause button to start the programme. Programme follow-up light showing the startup of the programme will turn on.

## Progress of programme

Progress of a running programme can be followed from the Programme Follow-up indicator with the lights "Running" and "End/Cancel".



### INFORMATIONS

If the machine does not pass to the spinning step, automatic unbalanced load detection system might have been activated due to the unbalanced distribution of the laundry in the machine.

## 4.10 Loading door lock

There is a locking system on the loading door of the machine that prevents opening of the door in cases when the water level is unsuitable.

If you want to open loading door when the machine is in use, press "Start / Pause" button to pause the machine. "Door Open" light will start flashing when the machine is switched to Pause mode. Machine checks the level of the water inside. If the level is suitable, "Door Open" light illuminates steadily within 1-2 minutes and the loading door can be opened. If the level is unsuitable, "Door Open" light turns off and the loading door cannot be opened. If you are obliged to open the loading door when the "Door Open" light is off, you have to cancel the current programme; see "Cancelling the programme".

### Switching the machine to pause mode

Press the "Start / Pause" button to switch the machine to pause mode while a programme is running. "Running" light starts flashing on the Programme Follow-up indicator to show that the machine has been switched to the pause mode.

When the loading door is ready to be opened, "Door Open" light will illuminate continuously.

## Adding or taking out laundry

Press "Start / Pause" button to switch the machine to pause mode. When the machine is switched to pause mode, "Running" light flashes. Wait until the Loading Door can be opened. Open the Loading Door and add or take out the laundry.

Close the Loading Door. Press "Start / Pause" button to start the machine.



### INFORMATIONS

The door can be opened if the water level is suitable. Door open symbol flashes until the loading door gets ready to be opened. The symbol's light is steady when the door is ready to open. You can open the door to add/take out laundry.

## 4.11 Cancelling the programme

To cancel the programme, turn the Programme Selection knob to select another programme. Previous programme will be cancelled. "End/Cancel" light will flash continuously to notify that the programme has been cancelled.



### INFORMATIONS

If you start a new programme after cancelling the previous one, this new programme will start without draining the water in the machine.

If you must certainly open the loading door when the "Door Open" light is off, you need to use "Spin+Pump" programme. See "Spin+Pump"

## Re-spinning the laundry

Unbalanced load control system can prevent spinning because of unbalanced load of laundry in the machine. If you would like to spin again:

Rearrange the laundry in the machine. Select Spin+Pump programme and press "Start / Pause" button.

## 4.12 End of programme

"End/Cancel" light on the programme follow-up indicator will light up once the programme comes to an end; and "Door Open" symbol flashes for 1-2 minutes until the door is ready to open. When "Door Open" symbol is steadily illuminated, the door can be opened.

To turn off the machine, turn program selection knob to "On / Off" position. Take out your laundry and close the loading door. The machine will be ready for the next run.

## 4.13 Door Open

"Door Open" symbol is illuminated when the door is ready to open. It flashes until the door gets ready to open. If the "Door Open" symbol is not illuminated, do not force the door to open. The symbol's light is steady when the door is ready to open.

## 4.14 Your machine is equipped with a "Standby Mode"

In case of not starting any programme or waiting without making any other operation when the machine is turned on by On/Off button and while it is in selection step or if no other operation is performed approximately 2 minutes after the programme you selected has come to an end, your machine will automatically switch to energy saving mode. Brightness of indicator lights will decrease. Also, if your product is equipped with a display showing the programme duration, this display will completely turn off. In case of rotating the Programme Selection knob or pressing any button, lights and display will restore to their previous condition. Your selections made while exiting the energy saving mode may change. Check the appropriateness of your selections before starting the programme. Readjust if necessary. This is not a fault.

## 5 Maintenance and cleaning

Service life of the product extends and frequently faced problems decrease if cleaned at regular intervals.

### 5.1 Cleaning the detergent drawer

Clean the detergent drawer at regular intervals (every 4-5 washing cycles) as shown below in order to prevent accumulation of powder detergent in time.

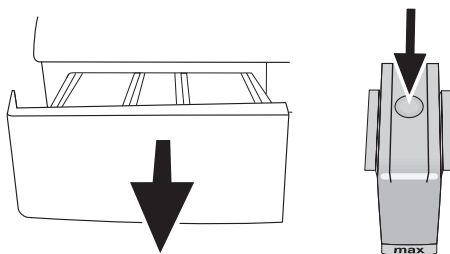

Press the dotted point on the siphon in the softener compartment and pull towards you until the compartment is removed from the machine.



### INFORMATIONS

If more than normal amount of water and softener mixture starts to gather in the softener compartment, the siphon must be cleaned.

Wash the detergent drawer and the siphon with plenty of lukewarm water in a washbasin. Wear protective gloves or use an appropriate brush to avoid touching of the residues in the drawer with your skin when cleaning. Insert the drawer back into its place after cleaning and make sure that it is seated well.

### 5.2 Cleaning the loading door and the drum

For products with drum cleaning programme, please see Operating the product - Programmes.

For products without drum cleaning, follow the below steps **to clean the drum:**

Select **Additional Water** or **Extra Rinse** auxiliary functions. Use a Cottons **programme** without

pre-wash. Set the temperature to the level recommended on the drum cleaning agent which can be provided from authorized services. Apply this procedure **without any laundry in the product**. Before starting the programme, put 1 pouch of special drum cleaning agent (if the special agent could not be supplied, put max. 100 g of powder anti-limescale) into the main wash detergent compartment (compartment no. "2"). If the anti-limescale is in tablet form, put only one tablet into the main wash compartment no. "2". Dry the inside of the bellow with a clean piece of cloth after the programme has come to an end.



### INFORMATIONS

Repeat Drum Cleaning process in every 2 months.

Use an anti-limescale suitable for the washing machines.

After every washing make sure that no foreign substance is left in the drum.

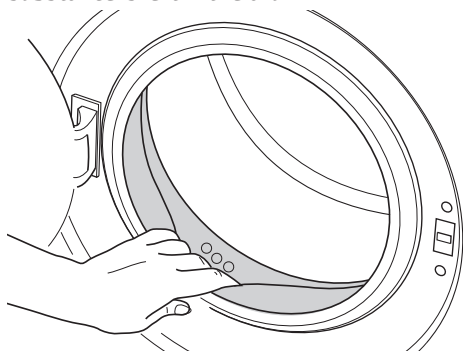

If the holes on the bellow shown in the figure is blocked, open the holes using a toothpick.



### INFORMATIONS

Foreign metal substances will cause rust stains in the drum. Clean the stains on the drum surface by using cleaning agents for stainless steel. Never use steel wool or wire wool.

## 5.3 Cleaning the body and control panel

Wipe the body of the machine with soapy water or non-corrosive mild gel detergents as necessary, and dry with a soft cloth.

Use only a soft and damp cloth to clean the control panel.



### WARNING

Never use sponge or scrub materials. These will damage the painted and plastic surfaces.

## 5.4 Cleaning the water intake filters

There is a filter at the end of each water intake valve at the rear of the machine and also at the end of each water intake hose where they are connected to the tap. These filters prevent foreign substances and dirt in the water to enter the washing machine. Filters should be cleaned as they do get dirty.

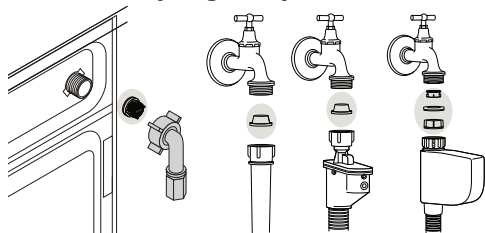

Close the taps. Remove the nuts of the water intake hoses to access the filters on the water intake valves. Clean them with an appropriate brush. If the filters are too dirty, take them out by means of pliers and clean them. Take out the filters on the flat ends of the water intake hoses together with the gaskets and clean thoroughly under running water. Replace the gaskets and filters carefully in their places and tighten the hose nuts by hand.

## 5.5 Draining remaining water and cleaning the pump filter

The filter system in your machine prevents solid items such as buttons, coins and fabric fibers clogging the pump impeller during discharge of washing water. Thus, the water will be discharged without any problem and the service life of the pump will extend. If the machine fails to drain water, the pump filter is clogged. Filter must be cleaned whenever it is clogged or in every 3 months. Water must be drained off first to clean the pump filter.

In addition, prior to transporting the machine (e.g., when moving to another house) and in case of freezing of the water, water may have to be drained completely.



### WARNING

Foreign substances left in the pump filter may damage your machine or may cause noise problem.

In order to clean the dirty filter and discharge the water:

Unplug the machine to cut off the supply power.



### WARNING

Temperature of the water inside the machine may rise up to 90 °C. To avoid burning risk, filter must be cleaned after the water in the machine cools down.

Open the filter cover by pulling it from both sides at the top.

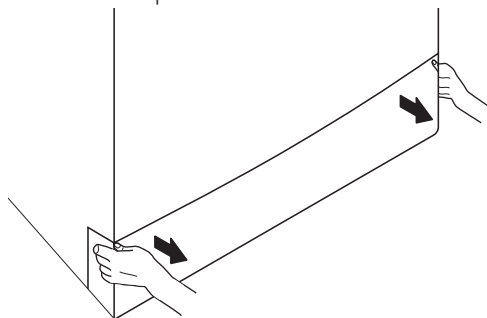

### INFORMATIONS

You can remove the filter cover by slightly pushing downwards with a thin plastic tipped tool, through the gap above the filter cover. Do not use metal tipped tools to remove the cover.

Follow the steps below to discharge the water.

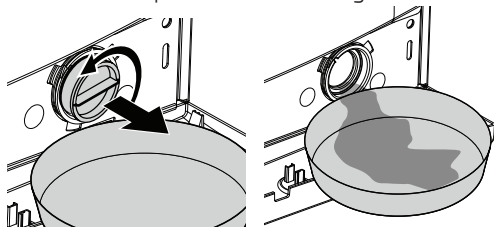

Place a large container in front of the filter to catch water from the filter. Loosen pump filter (anticlockwise) until water starts to flow. Fill the flowing water into the container you have placed in front of the filter. Always keep a piece of cloth handy to absorb any spilled water. When the water inside the machine is finished, take out the filter completely by turning it. Clean any residues inside the filter as well as fibers, if any, around the pump impeller region. Install the filter.

Seat the tabs in the lower part into their places first, and then press the upper part to close.

## 6 Technical specifications

---

Supplier name or trademark	Beko
Model name	EV 7102
Rated capacity (kg)	7
Maximum spin speed (rpm)	1000
Height (cm)	84
Width (cm)	60
Depth (cm)	50
Net weight ( $\pm 4$ kg.)	61
Single Water inlet / Double Water inlet • Available	• / -
Electrical input (V/Hz)	230 V / 50Hz
Total current (A)	10
Total power (W)	2200
Main model code	9410

## 7 Troubleshooting

Program does not start after closing the door.

- Start / Pause / Cancel button was not pressed. >>> \*Press the Start / Pause / Cancel button.

Programme cannot be started or selected.

- Washing machine has switched to self protection mode due to a supply problem (line voltage, water pressure, etc.). >>> To cancel the programme, turn the Programme Selection knob to select another programme. Previous programme will be cancelled. (See "Cancelling the programme")

Water in the machine.

- Some water might have remained in the product due to the quality control processes in the production. >>> This is not a failure; water is not harmful to the machine.

Machine vibrates or makes noise.

- Machine might be standing unbalanced. >>> Adjust the feet to level the machine.
- A hard substance might have entered into the pump filter. >>> Clean the pump filter.
- Transportation safety bolts are not removed. >>> Remove the transportation safety bolts.
- Laundry quantity in the machine might be too little. >>> Add more laundry to the machine.
- Machine might be overloaded with laundry. >>> Take out some of the laundry from the machine or distribute the load by hand to balance it homogeneously in the machine.
- Machine might be leaning on a rigid item. >>> Make sure that the machine is not leaning on anything.

Machine stopped shortly after the programme started.

- Machine might have stopped temporarily due to low voltage. >>> It will resume running when the voltage restores to the normal level.

Programme time does not countdown. (On models with display)

- Timer may stop during water intake. >>> Timer indicator will not countdown until the machine takes in adequate amount of water. The machine will wait until there is sufficient amount of water to avoid poor washing results due to lack of water. Timer indicator will resume countdown after this.
- Timer may stop during heating step. >>> Timer indicator will not countdown until the machine reaches the selected temperature.
- Timer may stop during spinning step. >>> Automatic unbalanced load detection system might be activated due to the unbalanced distribution of the laundry in the drum.



### INFORMATIONS

Machine does not switch to spinning step when the laundry is not evenly distributed in the drum to prevent any damage to the machine and to its surrounding environment. Laundry should be rearranged and re-spun.

Foam is overflowing from the detergent drawer.

- Too much detergent is used. >>> Mix 1 tablespoonful softener and ½ l water and pour into the main wash compartment of the detergent drawer.



### INFORMATIONS

Put detergent into the machine suitable for the programmes and maximum loads indicated in the "Programme and consumption table". When you use additional chemicals (stain removers, bleaches and etc), reduce the amount of detergent.

Laundry remains wet at the end of the programme

- Excessive foam might have occurred and automatic foam absorption system might have been activated due to too much detergent usage. >>> Use recommended amount of detergent.



### INFORMATIONS

Machine does not switch to spinning step when the laundry is not evenly distributed in the drum to prevent any damage to the machine and to its surrounding environment. Laundry should be rearranged and re-spun.



### WARNING

If you cannot eliminate the problem although you follow the instructions in this section, consult your dealer or the Authorized Service Agent. Never try to repair a nonfunctional product yourself.

